



PORTE IN LEGNO

WOOD

NATURALTM

© WOOD GLASS TEAM 2020.08_IT

WOOD GLASS TEAM[®]
connected with nature.



WOOD GLASS TEAM®

**IL LEGNO È UN MATERIALE
NATURALE E PREZIOSO PER
LE SUE ECCEZIONALI PROPRIETÀ**

È LA NATURA A CASA TUA E LA STORIA
DI TANTI ANNI INSCRITTA NEI SUOI NODI.

connected with nature.

INDICE

ACCESSORI E PARAMETRI

TELAJ	p. 5	➤
TELAJ REGOLABILI	p. 5	➤
OPZIONI DI MONTAGGIO	p. 17	➤
VETRI DECORATIVI	p. 19	➤
TINTE E COLORI	p. 18	➤
MISURE E PARAMETRI	p. 17	➤

MANIGLIE	p. 17	➤
CILINDRI E MASCHERINE	p. 15	➤
CERNIERE	p. 14	➤



WOOD NATURAL

PROGETTI
INDIVIDUALI

- Realizziamo anche le porte esterne in base al progetto e alle misure fornite dal cliente.

Gentilmente chiediamo di mandare le richieste e le quotazioni all' indirizzo: italia@woodnatural.pl

PORTE ESTERNE

modelli d'esempio

DZP1



DZR1



DZR1 DUO



DZR10



DZR20



PORTE DZP - CON PANNELLI

PORTE DZR - STRUTTURALI

DZR30



DZR40



DZR50



DZR60



DZR61 DUO



DZR70



DZR80



DZR90



DZR100



DZR110



DZR111



DZR120



DZR130



DZR131



DZR132



DZR140



DZR150



DZR160



DZR160 DUO



DZR170



DZR180 DUO



MARCHI



pino rovere meranti



IL LEGNO È DI PRIMA SCELTA



LA MATERIA PRIMA È ECOLOGICA

Opzioni: pino lamellare, meranti, rovere o altri tipi di legno (*su richiesta)

Per la produzione viene usato il legno di miglior qualità' consegnato solo da fornitori certificati.

Utilizziamo il materiale riciclabile al 100%: legno, vetro e alluminio.



2 DESIGN



RICCA GAMMA DEI COLORI E TINTE

p. 18



VASTA SCELTA DEI VETRI DECORATIVI

p. 19



ATTRAENTI FORME DEI PROFILI PER TELAI E FASCE

p. 5

1 ANTA



ANTA DISPONIBILE DESTRA O SINISTRA



APERTURA VERSO INTERNO O ESTERNO



PORTA AD UN'ANTA 90 cm > 110 cm



PORTA A DUE ANTE 130cm > 220cm



COSTRUZIONE STRUTTURALE O A PANNELLO

DESIGNAZIONI DI LARGHEZZA DEI SERRAMENTI

68 mm

78 mm

92 mm



CERTIFICAZIONE DI QUALITÀ WOOD NATURAL

Garantiscono la miglior qualità dei materiali e gli ottimi parametri tecnici e tecnologici dei nostri prodotti.



3 TELAIO



SISTEMA STANDARD



SISTEMA COMPLANARE



TELAIO REGOLABILE



TELAIO FISSO



OPZIONI DI SCELTA DEI PROFILI DELLE FASCE

4 VARIANTE



CILINDRI E SERRATURE

p. 15



ALTRI ACCESSORI E FINITURE

p. 17



FERRAMENTA

p. 14



SOPRALUCI E FISSI

p. 5



COSTRUZIONE DELL'ANTA



- **La struttura dell'anta viene fatta** con il legno incollato (3 o 4 strati), profili 68,78,92(mm)
- **Riempimento pieno:** tipo „sandwich” impermeabile di stratificato + strato termoisolante all' interno
- Riempimento in vetro:** vetrocamera a risparmio energetico con il vetro sicuro 33.1 dal lato esterno come standard (disponibile anche l'opzione del vetro decorativo pag.19)
- Guarnizione aggiunta tra la struttura e il pannello



SISTEMA STANDARD



SISTEMA COMPLANARE

Misure e parametri a pag.17 ➤

MAZZETTA COLORI E FINITURA SULLA SUPERFICIE



QUATTRO MANI DI VERNICE/
TINTA PER LA FINITURA



MAZZETTA TINTE MAZZETTA RAL

p. 18 ➤

ANTE, SOPRALUCI E FISSI - VARIANTI

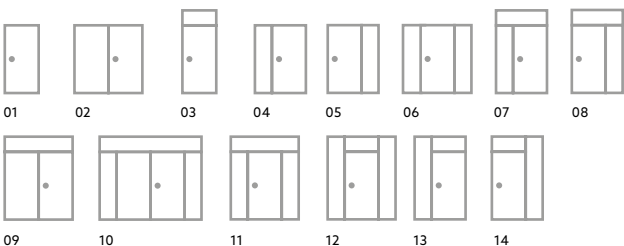

TELAIO



TELAIO FISSO



TELAIO REGOLABILE

- La costruzione del telaio viene fatto con il legno incollato a strati
- Telaio con la fascia regolabile da un lato
- Guarnizione aggiuntiva del telaio

FASCIE

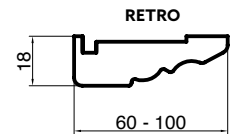
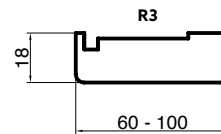

CERNIERE, CILINDRI, SERRATURE, FERRAMENTA

- Innovativo sistema delle cerniere per le porte in legno WOOD NATURAL nei sistemi standard e complanari
- Ferramenta dai profili in alluminio pieni disponibili in 3 livelli di sicurezza



p. 14 ➤



p. 15 ➤

- Cilindri e serrature multi punto con il meccanismo rinforzato „Multisafe”



p. 15 ➤

nature inside...

**WOOD DZP1 PLUS /
AXA MONTREAL 170 CM**

28

WOOD DOORS

DESIGNAZIONI
DI LARGHEZZA
DEI SERRAMENTI



Ante, sopraluci e fissi

-realizzazione disponibile per tutti i modelli

schemi a pag. 5



Nr Modello: **DZP1**



Nr Modello: **DZP1 PLUS**



Nr Modello: **DZP1 PLUS 2**



Nr Modello: **DZR1**



Nr Modello: **DZR1 PLUS**



Nr Modello: **DZR1 DUO**



Nr Modello: **DZR10**



Nr Modello: **DZR10 PLUS**



Nr Modello: **DZR20**



PORTE ESTERNE

OPZIONI

MISURE DELL'ANTA:

L 90 cm - 110 cm | H 203 cm - 220 cm

➔ p. 17

MATERIALE:

Rovere, Pino, Meranti



COLORI:

Mazzetta tinte, mazzetta RAL

➔ p. 18

FINITURA DELL'ANTA

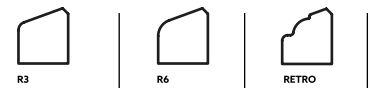

CERNIERE, CILINDRI, SERRATURA, FERRAMENTA

Ferramenta di sicurezza, cilindri e serratura multi punto

Cerniere nei sistemi standard e complanare (a scomparsa)

➔ p. 14 - 15

Cerniere nei sistemi standard e complanare (a scomparsa)

➔ p. 19

nature inside...

WOOD DOORS

DESIGNAZIONI
DI LARGHEZZA
DEI SERRAMENTI



Ante, sopraluci e fissi
-realizzazione disponibile per tutti i modelli schemi a pag. 5



Nr Modello: **DZR30**



Nr Modello: **DZR40**



Nr Modello: **DZR40 PLUS**



Nr Modello: **DZR50**



OPZIONI

MISURE DELL'ANTA:

L 90 cm - 110 cm | H 203 cm - 220 cm

➔ p. 17

MATERIALE:

Rovere, Pino, Meranti



COLORI:

Mazzetta tinte, mazzetta RAL

➔ p. 18

FINITURA DELL'ANTA

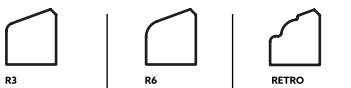

**CERNIERE, CILINDRI, SERRATURA,
FERRAMENTA**

Ferramenta di sicurezza, cilindri e serratura multi punto

Cerniere nei sistemi standard e complanare (a scomparsa)

➔ p. 14 - 15

Cerniere nei sistemi standard e complanare (a scomparsa)

➔ p. 19



Nr Modello: **DZR50 PLUS**



Nr Modello: **DZR60**



Nr Modello: **DZR60 PLUS**



Nr Modello: **DZR70**



Nr Modello: **DZR70 PLUS**



WOOD DOORS

DESIGNAZIONI
DI LARGHEZZA
DEI SERRAMENTI

68
mm

78
mm

92
mm



Ante, sopraluci e fissi

-realizzazione disponibile per tutti i modelli schemi a pag. 5



Nr Modello: **DZR61**



Nr Modello: **DZR80**



Nr Modello: **DZR90**



Nr Modello: **DZR90 PLUS**



Nr Modello: **DZR100**



Nr Modello: **DZR110**



Nr Modello: **DZR110 PLUS**



Nr Modello: **DZR111**



Nr Modello: **DZR120**



Nr Modello: **DZR120 PLUS**



* Opzioni - telai decorative

WOOD DOORS

DESIGNAZIONI
DI LARGHEZZA
DEI SERRAMENTI

68
mm

78
mm

92
mm



Ante, sopraluci e fissi

-realizzazione disponibile per tutti i modelli schemi a pag. 5



Nr Modello: **DZR130**



Nr Modello: **DZR130 PLUS**



Nr Modello: **DZR131**



Nr Modello: **DZR131 PLUS**



Nr Modello: **DZR132**



Nr Modello: **DZR132 PLUS**



Nr Modello: **DZR140**



Nr Modello: **DZR140 PLUS**



Nr Modello: **DZR150**



Nr Modello: **DZR150 PLUS**



- vista della porta dall'interno

PORTE ESTERNE

LINIA WOOD CLASSIC

DESIGNAZIONI
DI LARGHEZZA
DEI SERRAMENTI



Ante, sopraluci e fissi
-realizzazione disponibile per tutti i modelli schemi a pag. 5



Nr Modello: **DZR160**

Nr Modello: **DZR160 PLUS**

Nr Modello: **DZR160 DUO**

PORTE ESTERNE



Nr Modello: **DZR160 DUO PLUS**

OPZIONI

MISURE DELL'ANTA:
L 90 cm - 110 cm | H 203 cm - 220 cm

➤ p. 17

MATERIALE:
Rovere, Pino, Meranti

COLORI:
Mazzetta tinte, mazzetta RAL

➤ p. 18

FINITURA DELL'ANTA

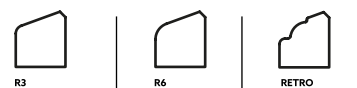

**CERNIERE, CILINDRI, SERRATURA,
FERRAMENTA**

Ferramenta di sicurezza, cilindri e serratura multi punto

Cerniere nei sistemi standard e complanare (a scomparsa)

➤ p. 14 - 15

Cerniere nei sistemi standard e complanare (a scomparsa)

➤ p. 19



Nr Modello: **DZR170**

Nr Modello: **DZR180 DUO**

WOOD DZR111



CERNIERE

**CERNIERE REGOLABILI EASY 3D PER LE PORTE
ESTERNE IN LEGNO, INSERITE NEI FORI
DEL TELAIO E DELL'ANTA**

Le cerniere SFS EASY 3D confermano le aspettative dei clienti: semplice regolazione anche a porta chiusa e garanzia del fluido funzionamento senza dover usare elementi autolubrificanti. Easy 3D sono predisposte per le porte d'ingresso pesanti, portefinestre e finestre.

La Certificazione CE conferma il perfetto funzionamento delle cerniere e la possibilità' del montaggio nelle porte antincendio.

Ottima resistenza all' erosione, nello standard il perno di sicurezza, la ricca scelta di colori e varietà' dei materiali garantisce alle porte un design e un'estetica unica nel suo genere.

SFS Easy 3D

- » visibile
- » regolazione in 3 direzioni
- » capacità' fino a 150kg
- » disponibile in 9 colori

Versione in stile barocco per le porte stilizzate

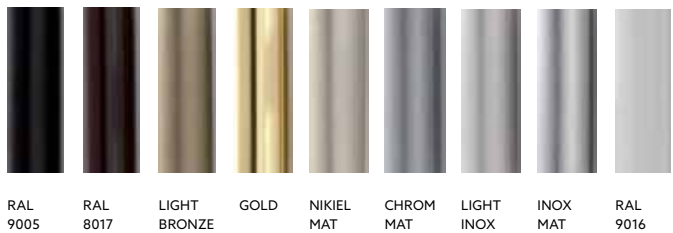

* I colori disponibili standard sono Light Bronze (F4) e Light Inox (F6)

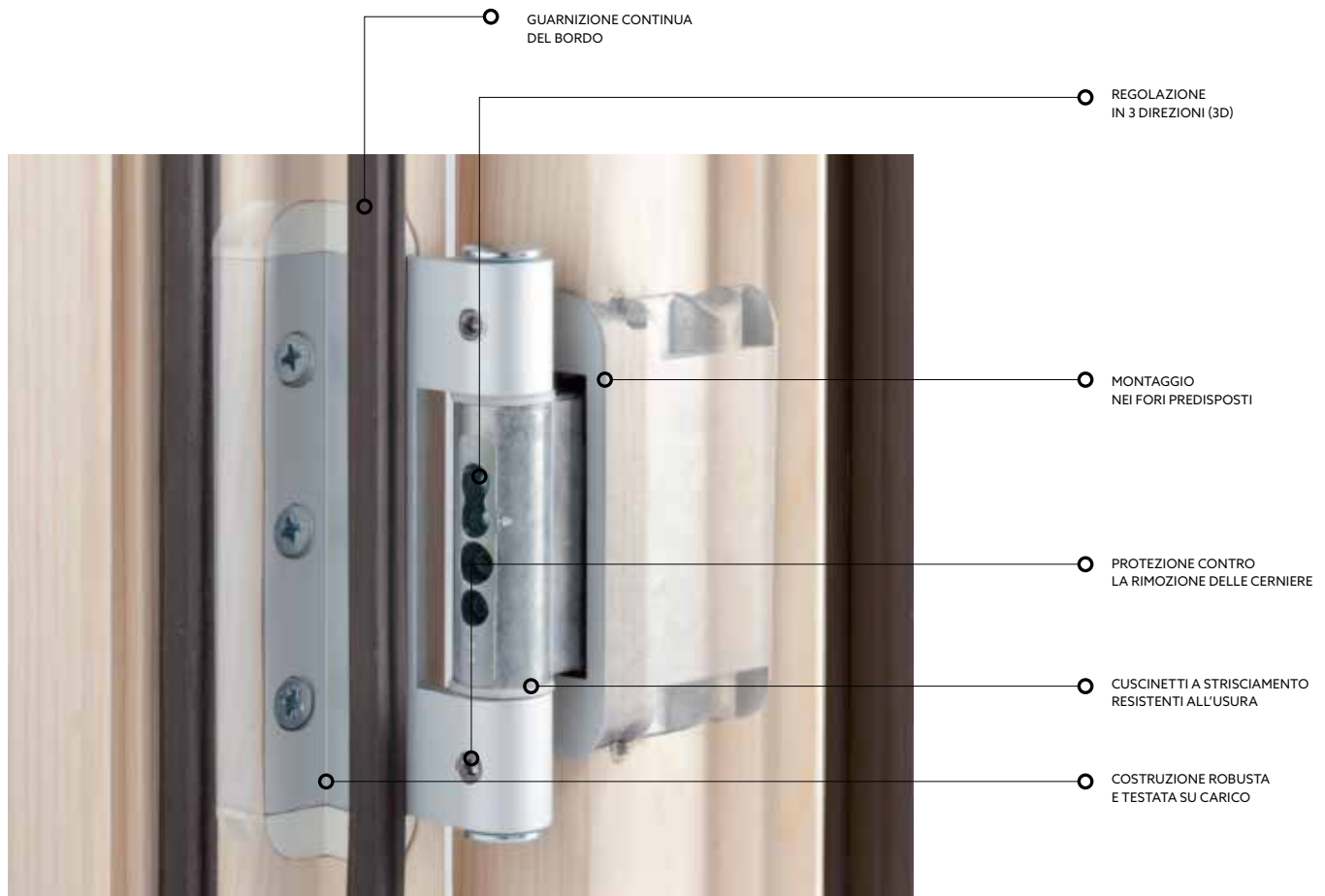



SERRATURE / PERNI

Piu' che standard. Le chiusure multipunto compatte di FUHR sono state appositamente sviluppate per le massime prestazioni sicurezza e praticità d'uso.



Sistema Smart Home FUHR (WLAN)

Grazie alla gestione intelligente dell'interfaccia dall'app SmartConnect easy, il sistema di controllo accessi si espande dando la possibilità del controllo della porta, aumentando così la sicurezza e garantendo il comfort di utilizzo:

- Notifiche push
- Date di serie
- semplice accesso alla rete
- Accesso ai trasmettitori radio FUHR e ai dispositivi esterni
- Integrazione Amazon Alexa / controllo vocale
- Cilindro digitale FUHR
- Apertura a due stadi



TIPO 855GL multisafe: 3 e 11
Serratura multi punti con tasto di funzionamento leggero grazie alla progettazione precisa dell'ingranaggio con un meccanismo permanente
- Sono stati testati 200.000 cicli secondo DIN 18251-3, classe 3

multisafe 856 e 859
Serratura multipunti attivata con maniglia (859 noce spaccata). La distribuzione della potenza avviene grazie al blocco tramite le maniglie con alloggiamento stabile.
- Sono stati testati 200.000 cicli secondo DIN 18251-3, classe 3

Serrature motorizzate, controllate digitalmente
834**881 GL**

Equipaggiamento aggiuntivo (opzione)



Chiusura esterna con rullo 150 mm, F16, con pressione aggiuntiva



Catena rigida per apertura limitata della porta,

**8042 PROTEZIONE ANTIEFFRAZIONE**

Lucchetto a cuneo, elemento di bloccaggio senza possibilità di regolazione 100 x 24 x 8 mm, elemento di bloccaggio con regolazione dell'alimentazione tramite vite Allen SW-4.



MANIGLIE / MANOPOLE / AN TABS

Sono realizzati con profili in alluminio completamente anodizzato (rivestiti con uno strato di ossido di alluminio con uno spessore di 12 micron), che garantiscono resistenza alla corrosione e alle condizioni meteorologiche, aumentando la durata della superficie - resistenza ai graffi. Un'ampia selezione di modelli e stili.

Maniglie e maniglioni

CLASSE DI SICUREZZA DI BASE

AXA HAGA PLUS

Spaziatura: 72 mm, 92 mm



AXA MANITOBA PLUS

Spaziatura: 72 mm, 92 mm



3 CLASSE DI SICUREZZA

AXA PRESTIGE FLEX

Spaziatura: 72 mm, 90 mm, 92 mm



AXA ROYAL FLEX

Spaziatura: 72 mm, 92 mm



4 CLASSE DI SICUREZZA

AXA TORONTO

Spaziatura: 72 mm, 92 mm



Maniglioni (antabs)

AXA AMSTERDAM INCLINATO / DRITTO

Lunghezza (cm) 50, 80, 100, 120, 150, 170

AXA MONTREAL INCLINATO / DRITTO

Lunghezza (cm) 50, 80, 100, 120, 150, 170



F6 inox



F4 oro antico



F1 argento



F3 oro



F8 nero



F9 titanio

*I Colori F6 inox e F4 oro antico disponibili di serie. Altri colori su richiesta.

PORTE ESTERNE

Porte a filo

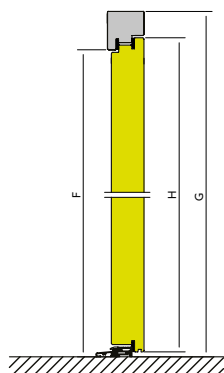
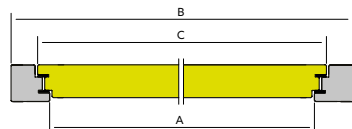

Porte con la battuta

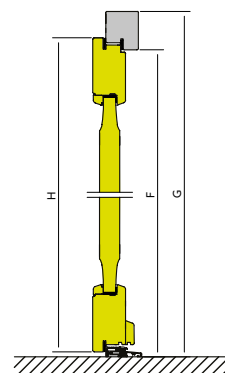
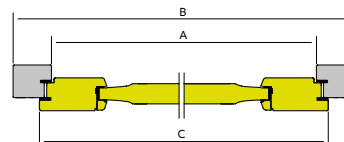

- A - larghezza libera del telaio della porta
- B - larghezza del telaio - dimensione senza i coprifili
- C - larghezza totale dell'anta
- F - altezza libera del telaio
- G - altezza del telaio - dimensione senza i coprifili
- H - l'altezza totale dell'anta

Tabella dimensionale - Profilo 68, 78, 92

TAGLIA	A	B	C	F	G	H
90	900	1060	950	2120	2200	2135
100	1000	1160	1050	2120	2200	2135

COLORI TRANSPARENTI

Le mazzette colore (trasparenti e RAL) hanno solo fine illustrativo.



VASTA GAMMA
DI COLORI

La tonalità e il tipo di legno influiscono in modo significativo sul colore finale del rivestimento (azzurro).

COLORI	LEGNO		
	PINO	ROVERE	MERANTI
PINIA			
PINO VECCHIO			
CIPRESSO			
IROKO			
CASTAGNO			
SIPO			
FRAMIRÈ			
SAPELLI			
Inco lo re			

COLORI	LEGNO		
	PINO	ROVERE	MERANTI
ROVERE			
CALVADOS			
NOCE			
KEMPAS			
AFROMOZIA			
CILEGIO			
WENGE			
ACAIOU			
OPAL WEISS			

COLORI COPRENTI RAL

Colori RAL di base sono disponibili come il standard

RAL 6009	RAL 7016	RAL 8011	RAL 8017
RAL 9001	RAL 9010	RAL 9016	RAL 7030

Colori coprenti su rovere o meranti possono manifestare le venature del legno, finitura coprente liscia e disponibile solo sulle costruzioni in pino.

Stuttura visibile	Liscio verniciato

Panelli delle porte

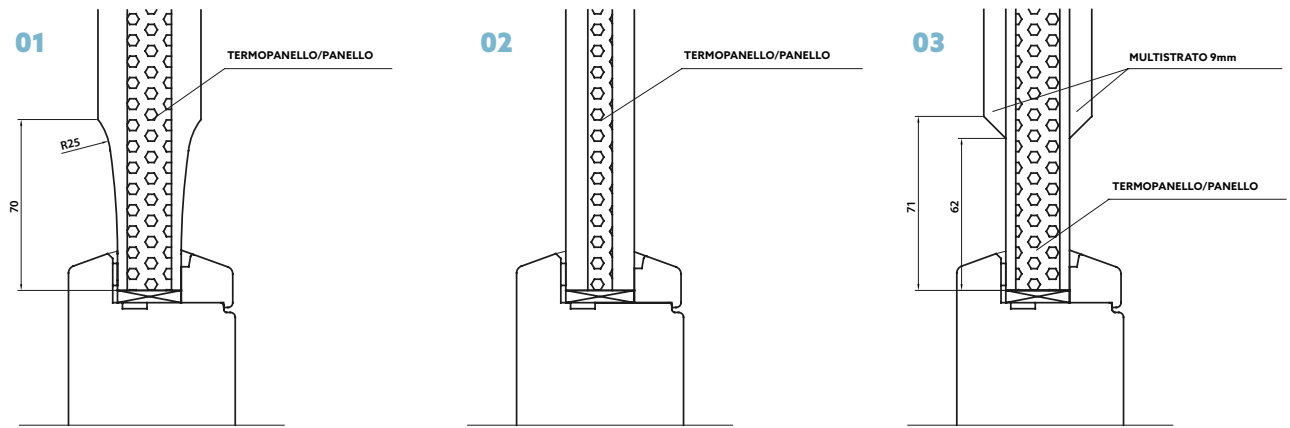

Il vetro ornamentale GLASS NATURAL è un materiale decorativo moderno con vari gradi di trasparenza e ispirato alla natura e alla contemporaneità.

- » Vetro laminato con trasparenza limitata, ma con la capacità di trasmettere luce;
- » Alta qualità e valori estetici;
- » Modo per garantire la privacy e ottenere vari effetti decorativi.

Ornamento

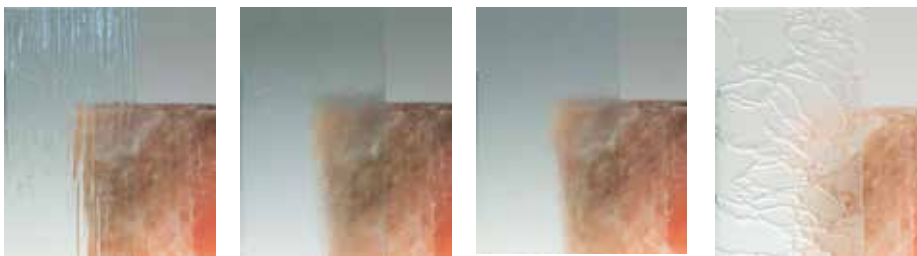

01 - Ornamento Kura

02 - Ornamento Chinchilla

03 - Ornamento Crepi

04 - Ornamento sabbia Delta opaco



05 - Ornamento Kathedral

06 - Ornamento Master Carre

07 - Ornamento Silvit

Altri



08 - Vetro bronzo antisol

09 - Vetro antisol grafite

10 - Vetro verde antisol

11 - Vetro float trasparente

12 - Laminato di vetro 33.1 Mat

13 - Vetro opaco

WOOD NATURAL[™]

WOOD GLASS TEAM[®]
connected with nature.

ul. Kardynała Wyszyńskiego 58
88-320 Strzelno



WWW.WOODNATURAL.PL

